



Contents lists available at <http://qu.edu.iq>

Al-Qadisiyah Journal for Engineering Sciences

Journal homepage: <http://qu.edu.iq/journaleng/index.php/JQES>



# Numerical investigation of the impact of various design parameters of finned-pipes on mixed convection

Rassol H. Rasheed\*, Majid H. Majeed and Ahmed Q. Mohammed

The Technical Engineering College, Middle Technical University, Baghdad, Iraq

## ARTICLE INFO

### Article history:

Received 30 November 2021

Received in revised form 28 January 2022

Accepted 10 March 2022

### Keywords:

Mixed convection

CFD

Enclosure

Ri

Finned pipes

## ABSTRACT

The mixed convection investigation of various design parameters utilizing finned pipes in the cylindrical enclosure has been investigated computationally. Various geometries of fins are used (circular and longitudinal). The effect of fins number (12-16), aspect ratio (1.83-2.7), radius ratio (2-3) and fins geometry have been introduced within the present study. The observations show that when Richardson number=0.5 and 5.5, the heat transfer decreases by 12.22% and 7.77%.. Values of the Nusselt number rise as the number of fins increases. While, when the Rayleigh number is high, no noticeable variations in the numbers of fins (12 and 14). The purpose of using fins is to increase the surface area of heat transmission. The highest heat transfer improvement is shown to be 4.2%, when  $\log(\text{Rayleigh})=7.342$  and 16 fins are utilized. The radius ratio does not affect Nusselt number throughout the whole Richardson and Rayleigh in both hot and cold locales. The turbulence sub-layer does not affect the free stream behaviour for different Richardson number. In the case of high Richardson number, the geometry does not influence the Nu. Longitudinal fins do not have dead zones, unlike circular fins, which have channelling generated by geometrical arrangement. To reach thermal equilibrium in a cold environment, the Nu in rectangular fins was reduced by 18% as compared to circular fins with a low Richardson number. Flow development would increase the impact of channelling. The heat transfer improvement decreases as the number of fins increases, as illustrated in temperature and velocity profiles for various values.

© 2022 University of Al-Qadisiyah. All rights reserved.

## 1. Introduction

A lid-driven cavity with mixed convection, which has been the focus of several scientific projects. This kind may be built using a mix of free and forced convection methods. In other words, when the buoyancy force is affected by the pumping force. Also, every external element that affects the current flow is represented by the movement of one or more cavity walls, rotating the cylinder or other geometry inside the cavity, and finding the pump or fan.

It is critical to discover an indicator of the relative magnitudes of convection when natural and forced convection interact. A dimensionless group ( $Ri = Gr/Re^2$ ) offers a measure of the ratio of buoyancy force to inertial force in mixed convection flow in the cavity. The following three flow regimes inside the enclosure are distinguished using this criterion [1]. The mixed convection has been greatly used in electronic devices cooling, mixing process, HVAC. Numerous investigations dealt with

\* Corresponding author.

E-mail address: [rassolfatimi@gmail.com](mailto:rassolfatimi@gmail.com) (Rassol Rasheed)

<https://doi.org/10.30772/qjes.v15i1.814>

2411-7773/© 2021 University of Al-Qadisiyah. All rights reserved.



This work is licensed under a [Creative Commons Attribution 4.0 International License](https://creativecommons.org/licenses/by/4.0/).

mixed convection due to its vital role in the industrial and domestically uses such as:

Mansour et al. [2] investigated steady-state, laminar, and three-dimensional objects mixed convection in a lid-driven cubical square cavity heated by its stationary lower wall. It was supposed that the top wall was chilly and going in the appropriate direction. The other walls were adiabatic. The findings were reported for  $(0.001 < Ri < 10)$ , with  $Re=100$  assumed to be the Reynolds number constant. They concluded that increasing the Richardson number improved the local Nusselt number. The mixed convection flow between inner-heated circular cylinder moving effectively counter and a trapezoid container was described by Khan, Khan, & Hasan, [3]. The trapezoidal enclosure's bottom and top sides were maintained adiabatic, while the two inclined walls were stored in the fridge. The impact of a static cylinder vs a moving cylinder in a square cage was compared. The revolving cylinder, as well as the inclination angle linked to sidewall effect, had a substantial impact on heat transmission, according to their results. Farough and Faraz [4] investigated numerically the natural mixed convection in a constant temperature square container comprising many pairs of hot and cold tubes using the SIMPLE algorithm based on the finite volume approach. The cylinder's surface has a stable temperature, while its walls are insulated and filled with Nanofluid. The findings demonstrated that altering the rotational motion of the hot and cold cylinder can change the heat transfer rate. Furthermore, altering the heat source/sink design from bottom - top to top - bottom dramatically reduces the heat transfer rate. In addition, the findings revealed that changing the orientation of the chilled cylinder from vertical to horizontal greatly reduces the number of screws. Selimefendigil et al. [5] carried out numerical simulations of mixed convection in a rectangular channel with an adiabatic and rotating cylinder in the middle and 2 layers of Nano-fluids and a porous medium. The bottom and top walls were heated and cooled separately. Furthermore, the remaining left and right walls were insulated. The impacts of Rayleigh number, nanoparticle size fraction, angular rotational velocity, Darcy number ranging from, and different sizes and positions of the cylinder on fluid flow and heat transmission were investigated numerically using FEA method. The effect of cylinder angular velocity on heat transfer enhancement was more pronounced for bigger cylinders. In all circumstances, the averaged heat transmission improved linearly as the volume fraction of the nanoparticle increases. The local and averaged Nusselt numbers were increased as the cylinder approached the higher wall. In a lid-driven rectangular channel with centre trapezoidal frame, (Gangawane & Manikandan, 2017) [6] investigated 2D laminar mixed heat transfer for Newtonian fluids. The left and right sides were cold; the top wall was flowing in the positive x direction, the top and bottom walls were both adiabatic, and all walls were fixed. It was concluded that raising  $(Pr)$  improved heat transmission on the surface triangle. However, the heat transfer progressively increased when  $Re=80-200$  for the  $(0 < Gr < 10^3)$ . Hussein [7] investigated computationally the entropy production of time dependent mixed convection in a three-dimensional right-angle triangular cavity air filled. The hollow's perpendicular to the right side was heated and flowed toward the enclosure centre, downward, or towards the cold inclined wall. In contrast, the inclined left wall maintained stationary and represented the cold wall. The bottom wall had been repaired and was regarded as hot. The investigation looked at the Richardson number, movement direction, and Bejan number's impacts. The conclusion was that when  $(Ri)$  grew, the mean Nusselt number and entropy generation grew as well. Zhang et al. [8] numerically investigated time dependent mixed convection in a 2D square enclosure with a concentric spinning circular cylinder. The container was completely devoid of air. The side walls had a cool temperature. The temperature in the cylinder surface was quite high. It was discovered that as the tangential velocity on the cylinder surface rose, the local Nusselt number fell. Mixed convection was explored in a 3-D enclosure with two inner spinning circular tube loaded with Nano-fluids

by Selimefendigil and Oztop, 2018 [9]. The study was carried out using the finite element method. The left and right surfaces were heated and cooled, while the remaining walls and revolving cylinder were kept at room temperature. Water was tested along with three different kinds of nanomaterials ( $TiO_2$ , Cu, and  $Al_2O_3$ ). The results showed that utilizing Cu-water Nano-fluid at a high Rayleigh number led to the highest rate of heat transmission. The rotating orientation of the cylinders had an impact on the average Nusselt number. Cu-water improved heat transmission by 38.10% compared to coolant fluid (water). Abdul sahib and Al-Farhany [10] empirically explored the mixed convection in a square enclosure divided into two levels. The tests were carried out using an adiabatic rotating cylinder at the middle of the cavity and an  $Al_2O_3$ -water Nano-fluid (upper layer) and superposed porous medium (bottom layer). The top and lower walls were adiabatic, the right wall was heated, and the left wall was chilled in the experimental investigation. When the concentration of nanoparticles is (0.06), the temperature differential ( $\Delta T$ ) between the cold and hot walls was (6, 8, and 10) °C, and the rotational velocity was (-50, -25, 0, 25, and 50) rpm. Adding more, the temperature profile within the cavity was (6, 8, and 10 °C). The findings revealed that the effect of cylinder rotation was limited to the cylinder itself. Furthermore, when the temperature gradient increases, the strength of the flow increases as well. Hussein, Hamzah et al. 2020 [11] computationally investigated mixed convection heat transfer between the inner circular spinning cylinder and the trapezoidal enclosure. Furthermore, the space between the enclosure and the inner body was separated into two layers: the upper layer was filled with copper-water Nano-fluid, while the bottom layer was filled with almost the same Nano-fluids submerged in a saturated porous media. Numerous non-dimensional factors, such as Darcy and Rayleigh values, nanofluid voids percent, and many design parameters, such as undulations number of a bottom wavy wall, inner body diameter and rotating speed, and porous layer thickness, were investigated by the authors. The findings showed that increasing Rayleigh, Darcy, Nano-fluids voids percentage, and inner body diameter rotations led to a rise in average Nusselt number, and thus improved heat transmission. El-Shorbagy et al., [12]. On a suitable heat sink, the researchers numerically modelled the convective heat transfer of  $Al_2O_3/CuO-H_2O$  hybrid Nano-fluids (HNFs) (HS). An isothermal HS carries the (HNFs) flow. On the upper wall, the NF stream was handled as a slip flow. The NF flow is influenced by a homogeneous magnetic field. To solve the algebraic problems, the control volume approach was combined with the SIMPLE algorithm. Fin depth was varied between 0.1 and 0.3 for this purpose. Furthermore, with four distinct layouts of fins for various thicknesses were studied. The results showed that dispersing a 3% volume of nanocomposites (NPs) in water at a 1:1 ratio increased heat transfer by 2.78 % and entropy generation (Seen) by 6.59 %, correspondingly. Dispersing CuO NPs were approved as having a high influence on the heat transfer improvement than  $Al_2O_3$  NPs. At varying Richardson numbers (Ri), a change in together for or pattern resulted in differing behaviour. Alshara et al., [13] experiential evaluation was carried out in 3-D laminar mixed convective heat transfer coefficient from extended surfaces in a rectangular duct with slope. Material of the lowest channel was exposed to a homogenous heat flow, while the other sides were isolated. In a various orientation rectangular duct, a series of empirical experiments for air flow with mixed convective heat transfer coefficient with longitudinal fins was performed. Sloped orientations with perpendicular in the ranges of 0- 75°. At various Reynolds numbers (1000- 2300) and the ranges of Gashof number ( $3 \times 10^8 - 1 \times 10^9$ ). The study was developed to assess the influence of slope on local reference temperature, heat transfer rate, and mean heat transfer rate. The observations of the empirical analysis showed that optimal angle for maximal heat transmission is 45 degrees. The direction of the fin's arrangement is also critical for improving heat exchange. Rout et al., [14]. For a stable and laminar flowing fluid within a pipe under made by mixing flow regime, the temperature profile of a from within finned pipe

has already been computationally calculated for different fin count, tallness, and structure by attempting to solve continuity equation of mass, dynamism, and energy utilizing Fluent 12.1 for a stable and laminar flowing fluid within a pipe. It was discovered that the number of fins is vital to keep the tube wall temperature to a minimal value. The fin height tallness had an upper limit above which the temperature profile is unaffected by fin height. During mixed fluid flow, the top surface of a straight pipe had a greater mean temperature than the bottom part. The effect of fin form on the heat transfer rate demonstrates that pyramidal fins have the lowest thermal resistance relative to rectangular- and T-shaped fins. Aside from the thermal properties, the pressure drop produced by the existence of fins had also been studied. Kopeć and Niezgodna-Żelasko [15], The article's optimization estimates were relevant to longitudinally finned pipes of a HVAC system evaporation working in natural steam outside air circulation circumstances. Undulating fin form distinguishes the finned surfaces. The paper describes the methods used to find the best geometrical parameters of a finned tube, in which heat simulations were done using the numerical method that represent a convective heat transfer flow on the finned surfaces. The optimal solution was driven by the lowest mass of the fin, and hence design variables corresponded to the number of fins ( $n = 6$ ), fin heights ( $h = 0.065$ ), and fin depth ( $s = 0.0015$  m) in the situation of maximizing heat input with least mass of a fin. The tubes with 10 fins with a length of  $h = 0.11$  m and a depth of  $s = 0.0018$  m permitted optimal heat input at the estimated mass of the fins inside the exchanger's tubes design, according to optimization estimates for maximum efficiency of the exchangers at constant load. For any mass and optimum thermal performance, the article presents a simpler technique of estimating the ideal geometrical features of the contour. (Dogan & Seriola, 2010) [16] explored a wide variety of altered Rayleigh numbers and varying fin height and distances, mixed convection transport via longitudinal fins on the inside of a horizontal. The effect of spacing, fin height, and heat flow intensity on mixed convective heat transfer coefficient using rectangular fin arrays warmed from underneath in a horizontal duct were investigated in empirical parameterized research. The best fin spacing for optimal heat transmission has been investigated. The constant heat parameter was achieved during the trials, and gas was employed as the coolants. When gas velocity solenoid valve was used, the speed of fluid exiting the duct was maintained virtually stable (0.15 - 0.16 m/s) such that the Reynolds value was constantly around 1500. Tests with altered Rayleigh numbers  $3 \times 10^7 - 8 \times 10^8$  with Richardson number 0.4 -5 were carried out. Fin height was changed from  $H_f/H = 0.25$  to  $H_f/H = 0.80$ , and non - dimensional fin separation was adjusted from  $S/H = 0.04$  to  $S/H = 0.018$ . The findings of an experimental investigation on mixed convective heat transfer coefficient showed that ideal fin separation for maximal heat transfer is  $S = 8-9$  mm, and the optimal fin separation is dependent on the amount of  $Ra^*$ . (Mishra, 2016) [17] This research focused on the computational model of a tube having inner fins that is exposed to mixed convection and undergoes natural and forced rate of heat transfer. s. The effect of several factors such as fin height, fin shape (rectangular, T-shaped triangular), heat flux, Reynolds number, and tube inclination (horizontal and vertical) on tube temperature rise has been investigated. It has been discovered that heat transmission is considerable for triangular fins, and that heat transfer is greater in perpendicular direction due to the buoyancy and boundary layer heat exchange than in parallel configuration. The collected data were compared to existing publications and found to be acceptable agreement. (Al-Taha, Osman, & Majeed) [18], in 2017, The enhancement of heat transmission capacity when these interfaces were curved and disrupted, as in undulating fins, pinned fins, slot and holed fins, is of particular interest. The problem of heat transmission for perforation fins under forced convection has been the focus of this paper. The thermal efficiency was investigated for a set of rectangle fins implanted with various vertical body perforation patterns that run the length of the fin thickness. Perforation (circular, square,

rectangular) and enlarged fin were amongst the designs. The extent to which the hole improved the transfer rate relative to the corresponding traditional fin was investigated. When square and circular hole patterns were similar in perforation area, the fin with rectangular holes demonstrates a larger heat transport increase (16 % of non-perforated) ( $24\text{cm}^2$ ). The fin having square holes had a greater heat transfer enhancement (13 % vs. non-perforated) than the fin with circular holes, which had roughly the same heat transfer performance (11 % of non-holed). Due to temperature drop, the effectiveness of the perforation fin was lower than that of non-perforated fin (82.97 % of non-perforated). On the other hand, as long even as thermal transfer rate ratio was more than unity, the efficacy of the holed fin is better than those of the non-holed fin (1080% of non-holed). Retractable fins were very well being in great demand. Considerable weight loss (66-96 % of non-perforated) was shown, because both the surface and the heat transfer rate were increased at almost the same moment.

The present work is aimed to investigate numerically the mixed convection inside a cylindrical enclosure. In addition, to study the effect of various design parameters such as: fins number, aspect ratio, radius ratio and fins geometry on Nusselt number. Finally, observing the parametric behaviour in heat transfer performance in current system by generating the temperature and flow contours.

## 2. The theoretical aspect

The cylindrical enclosure is used to place four pipes with equal distances from the center. Two of these pipes are subjected to a uniform heat power while the others are subjected to the ambient temperature from the interior surface. Many parameters such as Rayleigh number is used for various distances, orientations, fins numbers, fins size, fins type in free convection additional to Richardson Number in mixed convection case. The geometries are presented in Figure 1.

The assumptions are placed by modifying the geometry coordinate, physics conservation equations, boundary conditions and study pattern. For the present investigations, the assumptions are summarized as following:

1. Steady state models.
2. The geometry coordinate is three dimensions with constant surface area and symmetric with finite slides with perpendicular direction.
3. The boundary walls are non-slip conditions.
4. The fluid flow is laminar.
5. Constant physical properties except the density variation with temperature (Boussinesq approximation) and pressure.
6. The radiation effect and the energy dissipations had been neglected.

The main applied physics in present work are momentum transport (turbulent  $k-\epsilon$ ) and heat transfer through fluid and solid. The complex partial differential equations are converted into algebraic equations based on force balance and heat balance with control system by mean of mesh distribution. The Multiphysics coupling is enabled by interaction between velocity and temperature distribution. The velocity components are used for convection purpose in heat transfer equation while the temperature can manipulate the physical properties which are polynomial expressions.

The following conservation equations are used for momentum:

-Momentum Equation

$$\rho(U \cdot \nabla)U = \nabla \cdot (-\rho L + K) + F + \rho \quad (1)$$

-Continuity equation

$$\nabla \cdot (\rho U) = 0 \tag{2}$$

-Kinetics expressions

$$K = (\mu + \mu_t)(\nabla U + (\nabla U)^T) - \frac{2}{3}(\mu + \mu_t)(\nabla U)l - \frac{2}{3}\rho k l \tag{3}$$

$$\rho(U \cdot \nabla)k = \nabla \cdot \left[ \left( \mu + \frac{\mu_t}{\sigma_k} \right) \nabla k \right] + \rho_k - \rho \mathcal{E} \tag{4}$$

$$\rho(U \cdot \nabla)\mathcal{E} = \nabla \cdot \left[ \left( \mu + \frac{\mu_t}{\sigma_{\mathcal{E}}} \right) \nabla \mathcal{E} \right] + C_{\mathcal{E}1} \frac{\mathcal{E}}{k} \rho_k - C_{\mathcal{E}2} \rho \frac{\mathcal{E}^2}{k} \tag{5}$$

$$\mu_t = \rho \frac{C_{\mu} k^2}{\mathcal{E}} \tag{6}$$

$$\rho_k = \mu_t \left[ \nabla U : (\nabla U + (\nabla U)^T) - \frac{2}{3}(\nabla \cdot U)^2 \right] - \frac{2}{3}\rho k \nabla \cdot U \tag{7}$$

Where: The k- $\mathcal{E}$  turbulent model constants which are derived from COMSOL software for general fluid,  $C_{\mathcal{E}1}=1.33$ ,  $C_{\mathcal{E}2}=1.92$ ,  $C_{\mu}=0.09$ ,  $\delta k=1$  and  $\delta \mathcal{E}=1.3$ . For heat conservation, following equation is used:

-Heat equations

$$\rho C_p U \nabla T + \nabla \cdot q = Q_{sum} \tag{8}$$

$$q = -\zeta \nabla T \tag{9}$$

-Calculate the inlet velocity from the expression bellow

$$U = \frac{g \beta (T_h - T_{\infty}) L}{Ri} \tag{10}$$

To design the longitudinal fins which have the equivalent surface area of circular fins. Defining the surface for each one is needed. The circular fins surface area [19-20]:

$$S_1 = n[2 \pi (R_2^2 - R_1^2) + 2 \pi R_2 t] \tag{11}$$

The longitudinal fins surface area:

$$S_2 = 4[2 t w + h t + 2 h w] \tag{12}$$

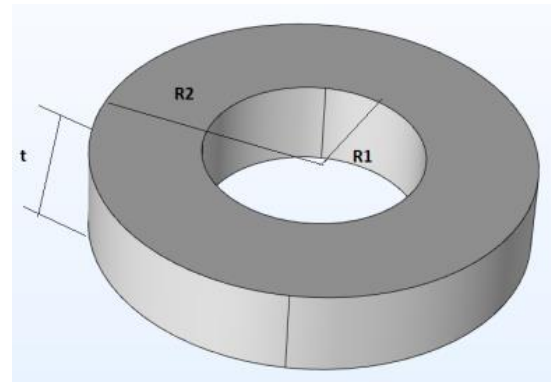

(a) Circular fin

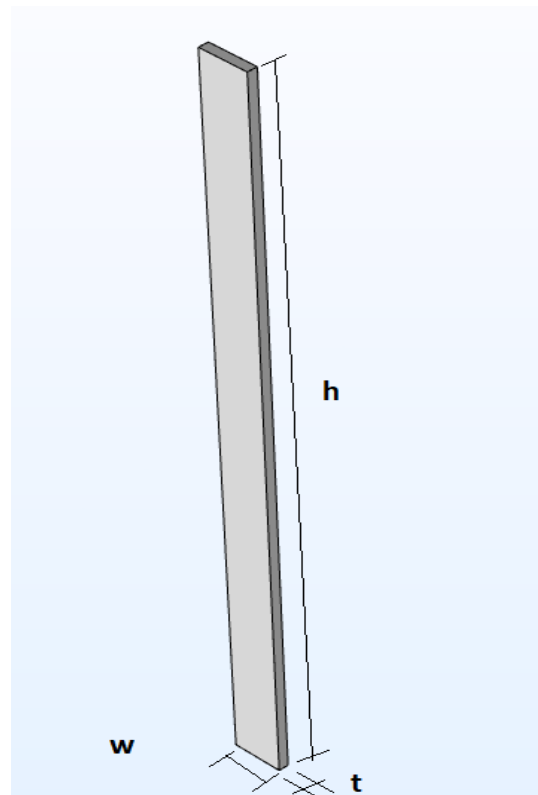

(b) Longitudinal fin



a. Circular finned

b. Without fin



c. longitudinal finned pipe

Figure 1. Geometrical configuration.

Figure 2. Fins characteristics dimensions.

Let  $S_1=S_2$

$$n[2 \pi (R_2^2 - R_1^2) + 2 \pi R_2 t] = 4[2 t w + h t + 2 h w]$$

$$2 \pi n[(R_2^2 - R_1^2) + R_2 t] = 4[2 w (t + h) + h t]$$

Then:

$$w = \frac{2 \pi n[(R_2^2 - R_1^2) + R_2 t] - 4 h t}{8 (h + t)} \tag{13}$$

Applying of conservation equations of mixed convection system needs to set up the appropriate boundary conditions such as:

- Inlet flow: velocity inlet (from top).
- Outlet pressure: from bottom.
- Constant pipe inner surface heat flux surface.
- Isotherm cold pipe inner surface temperature.
- Wall function for interior (pipes walls) and exterior walls (enclosure walls,  $U=0$ ).
- Inlet Temperature: the temperature of inlet fluid.

Where the  $w$  is manipulated by the number of circular fins and the outer length of the circular fins (Radius ratio  $R$ ).

The various Parameters are taken in considerations through the present work investigation:

- Aspect ratio ( $As$ ): is the ratio between the enclosure diameter to the diagonal distance between the pipes.
- Radius ratio ( $R$ ): is the ratio of fins radius to pipe radius.
- Richardson number: is the ratio of  $Gr$  to  $Re^2$ , ( $Ri=Gr/Re^2$ ).

### 3. Results and discussion

#### 3.1. The effect of Richardson number without fins case

Figures 3 and 4 show  $Nu$  vs.  $\log Ra$  for various  $Ri$  whereas  $As=1.83$  for cold and hot pipes regions. The increase of  $Ri$  drops the  $Nu$  values significantly for both hot and cold regions. The high values of  $Ri$  promote the free convection mechanism while the lower  $Ri$  makes the heat transfer turns toward the forced convection. The  $Ri$  is considered the main criteria for heat transfer behaviours when the mixed convection is performed inside the enclosure. in the observations in fig.3 show that the heat transfer from a hot surface to a bulk fluid is 40 % higher than the heat transfer from a cold surface to a bulk fluid. This is because the heat transfer contact period duration in the hot zone is longer than the cold region.

#### 3.2. The effect of aspect ratio

Figures 6 and 7 show Nusselt number vs. Rayleigh number for various  $As$  in smooth two heat pipes in both hot and cold surfaces. In the hot pipe region, the  $Nu$  values increase by increasing  $As$  as the 11.11 % heat transfer enhancement is observed at  $Ri=0.5$  and 20.8 % is observed at  $Ri=5.5$ . In cold pipe region the opposite behaviour to hot pipe region is observed. The heat transfer performance is shown to decrease when the aspect ratio increasing. The heat transfer decreased by 12.22 % and 7.777 % for  $Ri=0.5$  and  $Ri=5.5$  respectively. The rising of aspect ratio generates higher volume mixing between the hot pipe region and free stream. while the lower mixing intensity between the cold region fluid volume with the free stream (film temperature region).

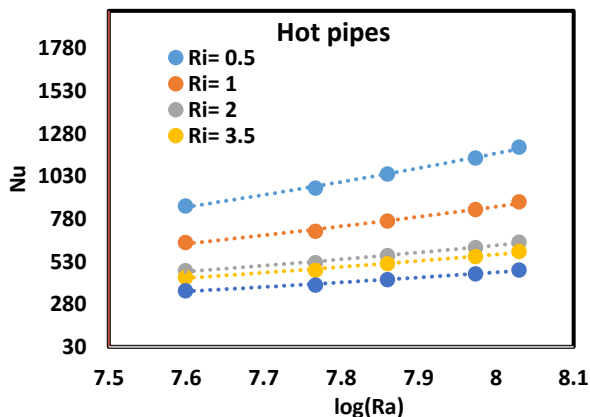

Figure 3. Nusselt number vs. Rayleigh number for various  $Ri$ ,

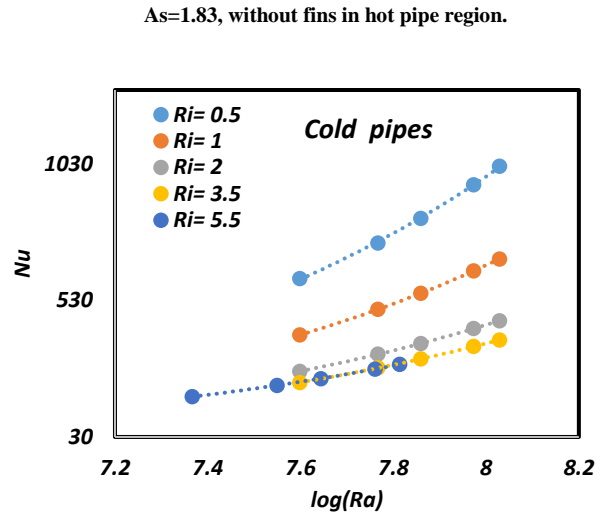

Figure 4. Nusselt number vs. Rayleigh number for various  $Ri$ ,  $As=1.83$ , without fins in cold pipe region.

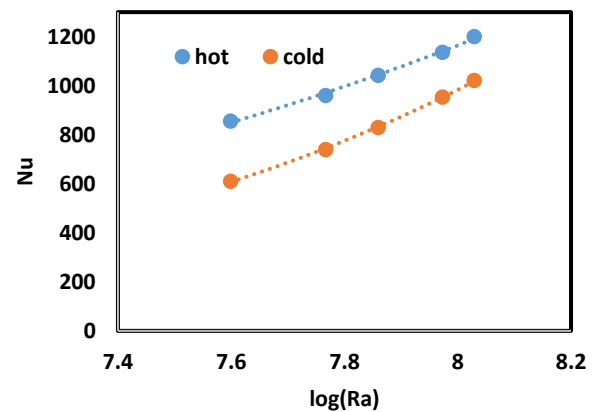

Figure 5. Nusselt number vs. Rayleigh number,  $As=1.83$ , without fins in both hot and cold pipe regions.

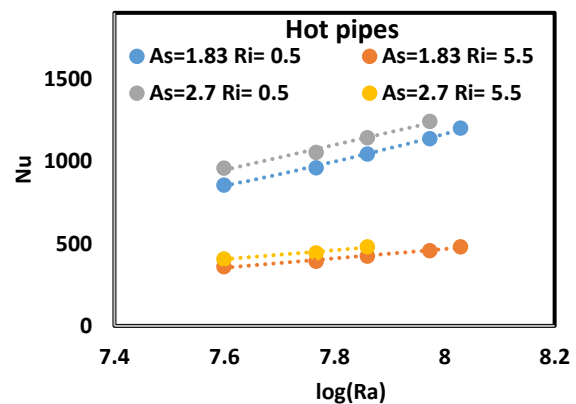

Figure 6. Nusselt number vs. Rayleigh number for various aspect ratio, without fins in hot pipe region.

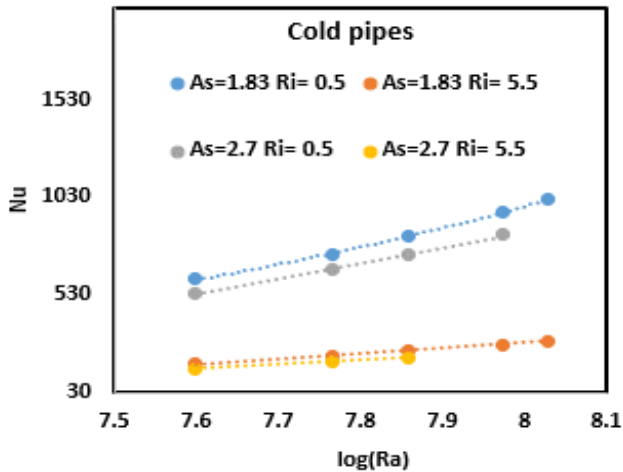

Fig. 7: Nusselt number vs. Rayleigh number for various aspect ratio, without fins in cold pipe region.

3.3. The effect of fins number (Circular fins)

Hot pipe Nusselt number vs. Rayleigh number for various circular fins numbers is shown in Figure 8. In high Ra, the range of Nu values grow as the fins number increases, with no notable changes for the lower numbers (12 and 14). The rising of Ri decreases the Nu, the behaviour in this case is approximately similar to the case of without fins. The heat transfer of hot region is higher than the cold region approximately by 40 % for whole Ra and Ri. The increase of Ri is higher than Ri=0.5 case. The sharp decrease of Nu occurs for furthermore Ri the decreasing in Nu is low decreasing sharply.

Cold pipe Nusselt number vs. Rayleigh number for various circular fins numbers is shown in fig 9. Similarly, Nu range values grow as fins number increases, with no noticeable modifications for smaller numbers (12 and 14) in high Ra conditions, such as the hot side. When log (Ra)=7.34 and 16 fins are used, the maximum heat transfer improvement is shown to be 4.2 %. The difference in Nu behaviour between hot and cold pipes is clear, with the number of fins having a greater impact on the Nu.

3.4. The effect of radius ratio, R, (Circular fins)

Nusselt number vs. Rayleigh number for varied R in as=1.83, 12 fins, and both hot and cold zones are shown in Figures 10 and 11. Throughout both hot and cold locations, the radius ratio has shown no influence on Nu for the whole Ri and Ra. For varied Ri, the turbulence sub-layer has no influence on the free stream behaviour. For a single Ri, the whole plot in the cold zone has values that are relatively close. When the fluid flow subjects the current system, the dead zone heat transfer rises, which eliminates the heat transfer enhancement caused by boundary layer destruction.

3.5. The effect of aspect ratio (As) (Circular fins)

Figures 12 and 13 show the Nusselt number vs. Rayleigh number in various As, R=2 and 12 circular fins for both hot and cold pipe regions. The Nu increases by increasing the as in hot pipe region and decreases by increasing as in cold pipe region. The heat transfer system needs the integration between the hot and cold regions heat transfer with the free stream to achieve the thermal equilibrium. In other words, the amount of Nu number increases directly with as needs the reverse behaviour with As in cold region to achieve the thermal equilibrium. The temperature difference between cold region and free stream increase by reducing the

temperature difference between hot surface and free stream. Geometries with smooth pipe for various Ri and both hot and cold heat pipe regions. The longitudinal fins have maximum Nu above the circular fins and without fins case by 12 % for low Ri. The geometry has shown no significant effect on the Nu when Ri is high. The dead zones are not presented in longitudinal fins unlike the circular fins which the channelling is formed due to geometrical configuration. For the cold region, the Nu decreases by 18 % in rectangular fins compared with circular fins in low Ri number to achieve the thermal equilibrium. The high Ri makes the geometry has no significant effect on Nu. The inertial force due to the turbulent flow development is the main mechanism which is applied within the present system in general. The resultant inertial force is higher than the volume force (resulted from the gravity and density gradient). Unlike the density difference force, the geometry of fins has no great impact on heat transfer performance where the high inertial force is presented. Figures 14 and 15 show the Nu vs. log Ra for various fins.

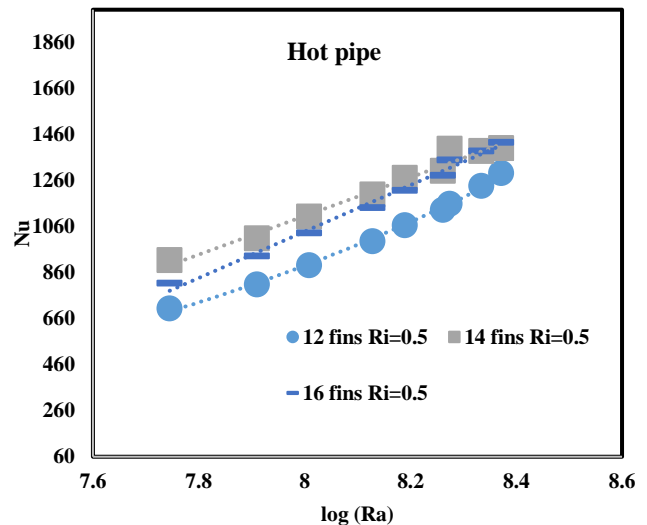

Figure 8a. Nusselt number vs. Rayleigh number at Ri=0.5 and various fins number in hot pipe region.

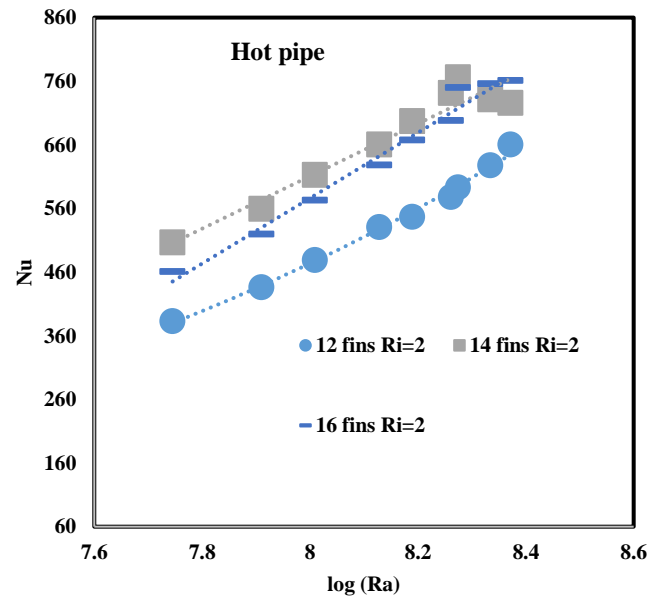

Figure 8b. Nusselt number vs. Rayleigh number at Ri=2 and various fins number in hot pipe region.

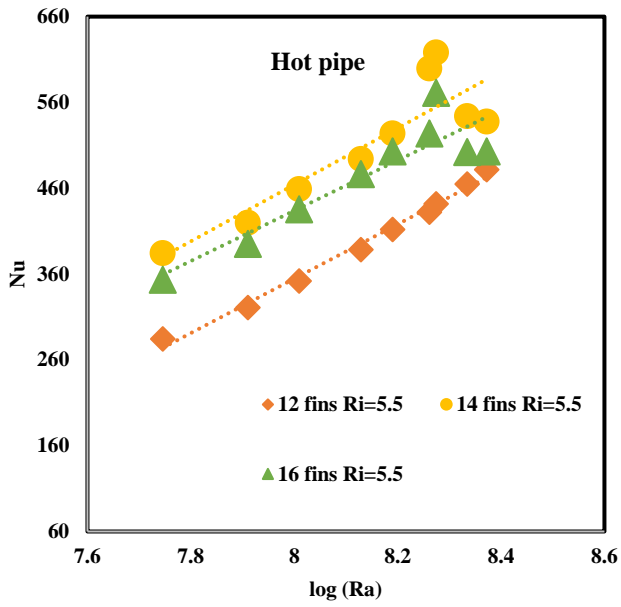

Figure 8c. Nusselt number vs. Rayleigh number for  $Ri=2$  and various fins number in hot pipe region.

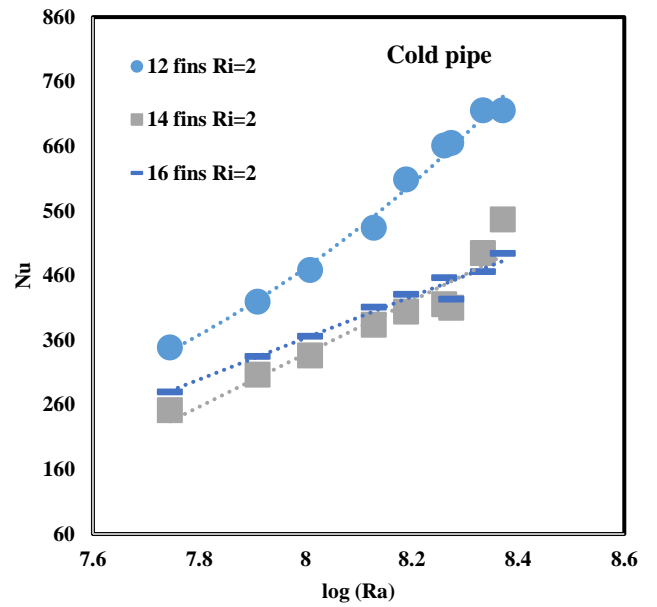

Figure 9b. Nusselt number vs. Rayleigh number at  $Ri=2$  and various fins number in cold pipe region.

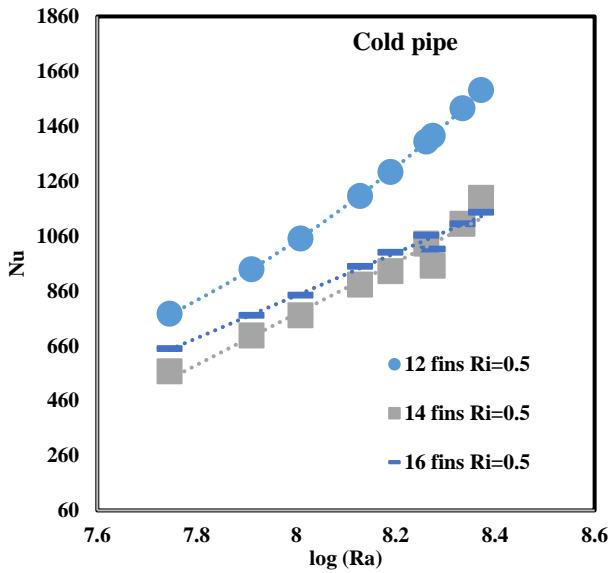

Figure 9a. Nusselt number vs. Rayleigh number for  $Ri=0.5$  and various fins number in cold pipe region.

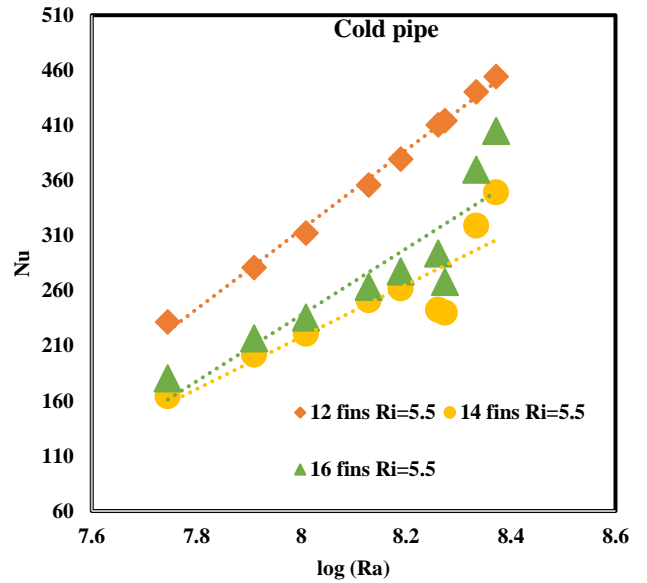

Figure 9c. Nusselt number vs. Rayleigh number for  $Ri=5.5$  and various fins number in cold pipe region.

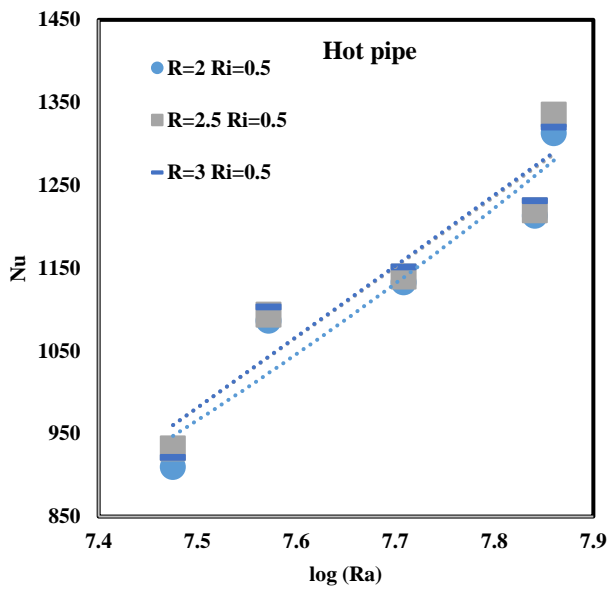

Figure 10. Nusselt number vs. Rayleigh number at Ri=0.5 and various R in hot pipe region.

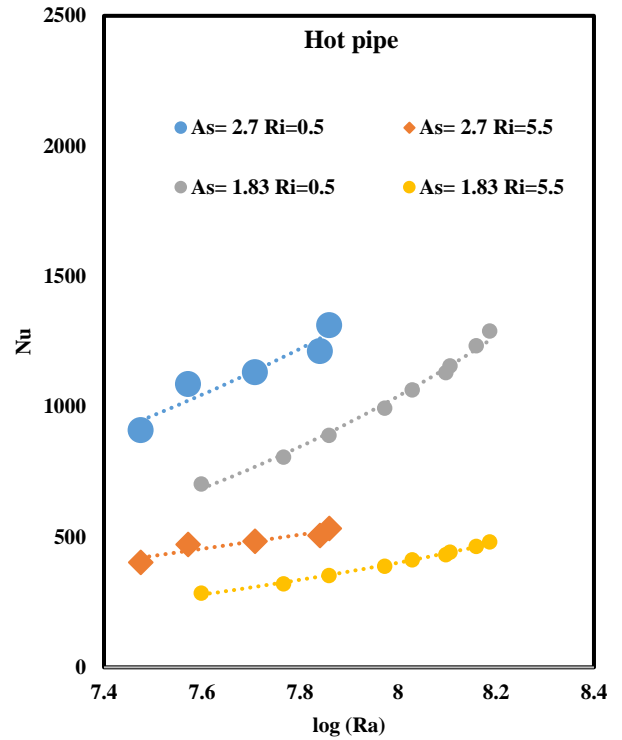

Figure 12. Nusselt number vs. Rayleigh number for various Ri and As in hot pipe region.

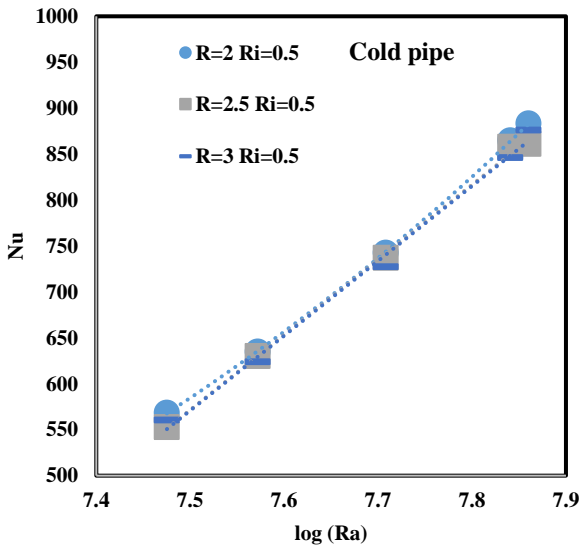

Figure 11. Nusselt number vs. Rayleigh number for Ri=0.5 and various R in cold pipe region.

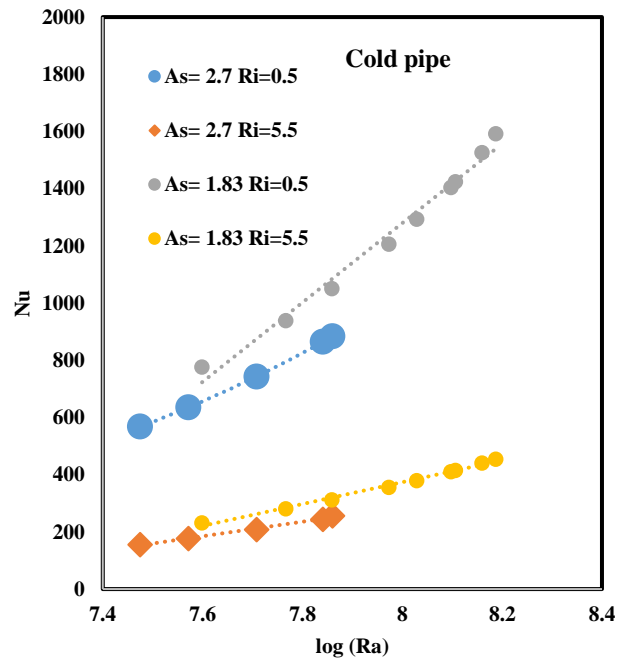

Figure 13. Nusselt number vs. Rayleigh number for various Ri and As in cold pipe region.



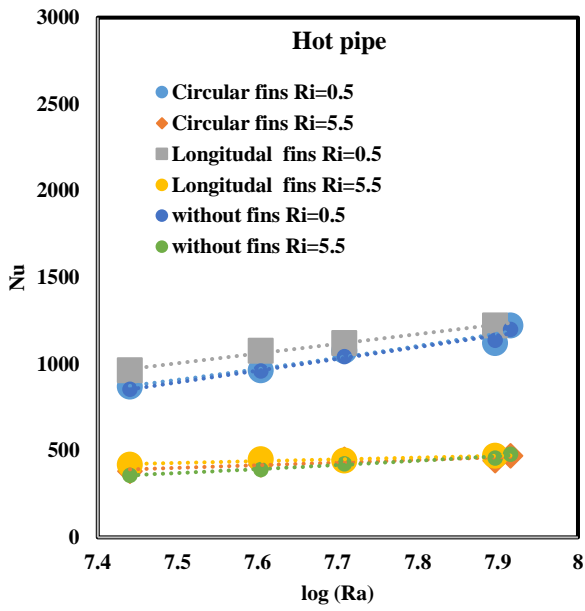

Figure 14. Nusselt number vs. Rayleigh number for various Ri and fins geometries in hot pipe region.

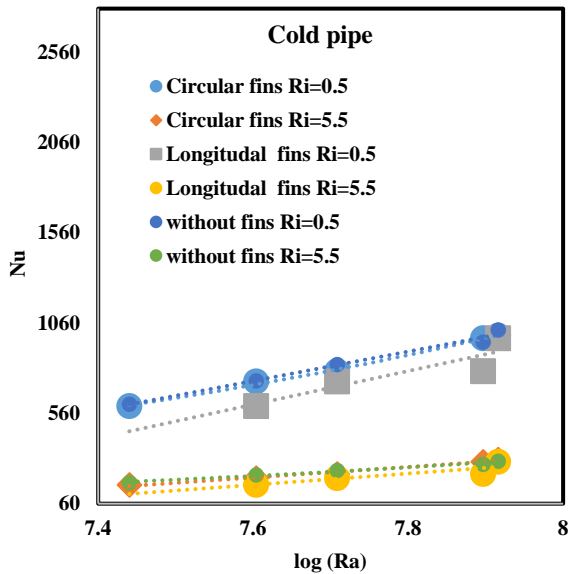

Figure 15. Nusselt number vs. Rayleigh number for various Ri and fins geometries in cold pipe region.

3.6. The contour analysis

The more warmed surface is getting to be red, and the cold surface prevails the blue colour as shown in legend bar. Figure16 shows the contour analysis (velocity and temperature) of mixed convection; circular finned pipe is used as heated pipe. The increase of fins number growths the attributing of flow inside the enclosure. The effect of channelling would be maximized by flow development. The maximum numbers of fins, the heat transfer enhancement decreasing is occurred.

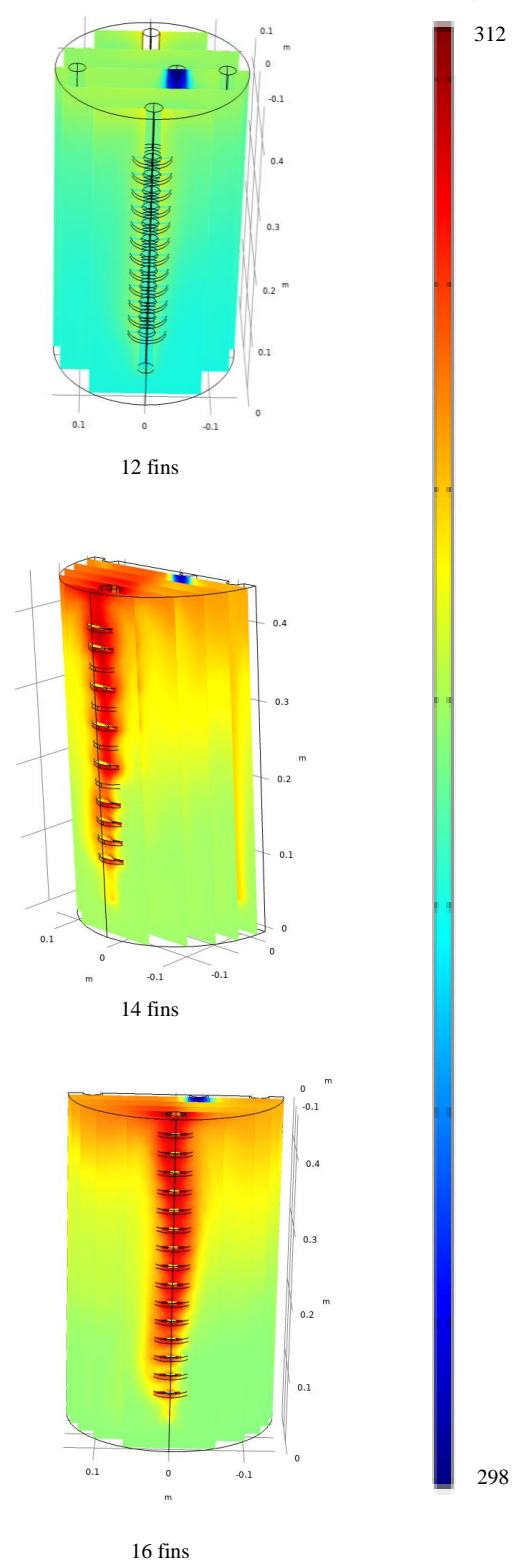
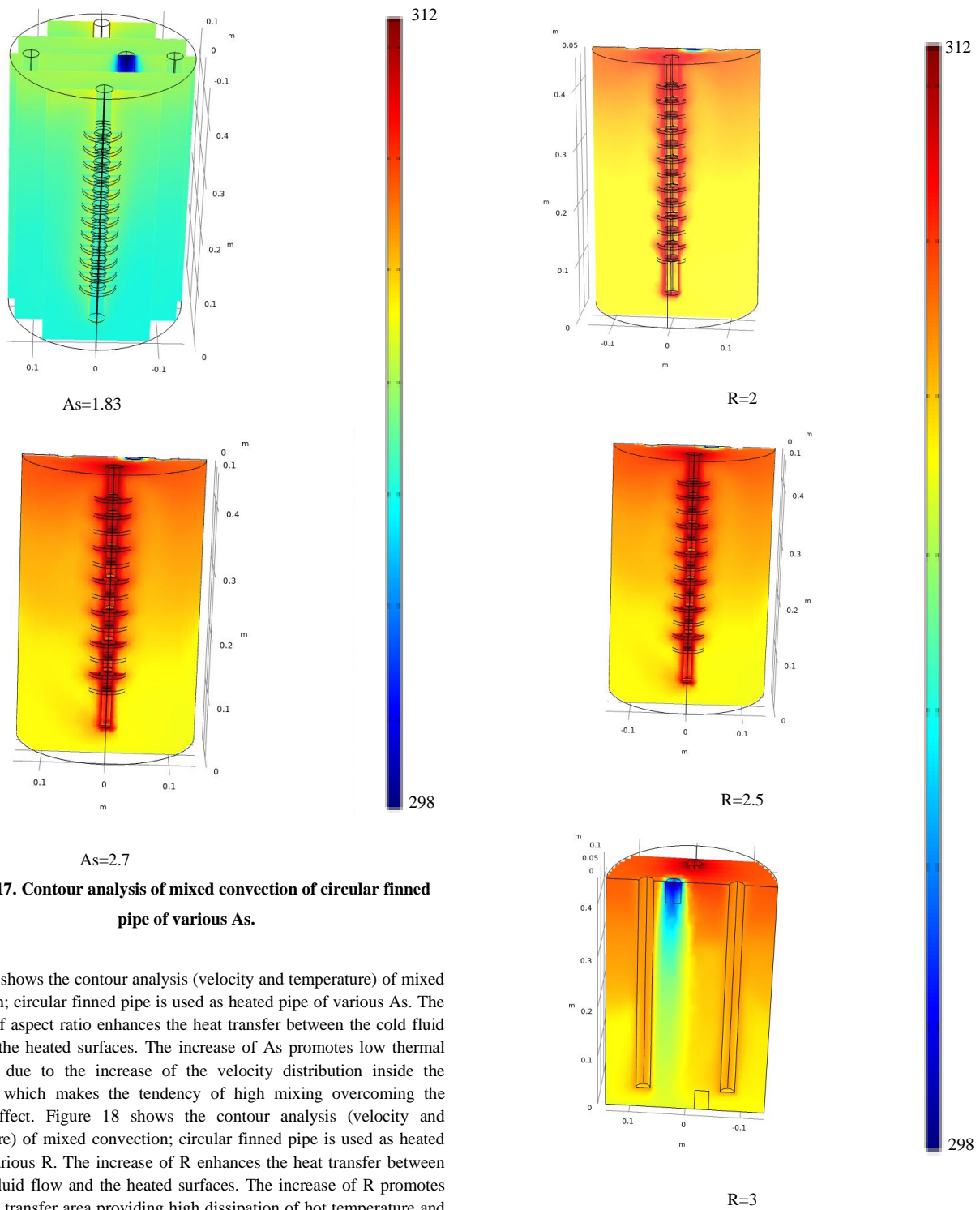

Figure 16. Contour analysis of mixed convection of circular finned pipe of various fins number.



**Figure 17. Contour analysis of mixed convection of circular finned pipe of various  $A_s$ .**

Figure 17 shows the contour analysis (velocity and temperature) of mixed convection; circular finned pipe is used as heated pipe of various  $A_s$ . The increase of aspect ratio enhances the heat transfer between the cold fluid flow and the heated surfaces. The increase of  $A_s$  promotes low thermal resistance due to the increase of the velocity distribution inside the enclosure which makes the tendency of high mixing overcoming the viscous effect. Figure 18 shows the contour analysis (velocity and temperature) of mixed convection; circular finned pipe is used as heated pipe of various  $R$ . The increase of  $R$  enhances the heat transfer between the cold fluid flow and the heated surfaces. The increase of  $R$  promotes the heated transfer area providing high dissipation of hot temperature and velocity to bulk fluid through the fluid flow for various  $R_i$ .

Figure 19 shows the contour analysis (velocity and temperature) of mixed convection; finned pipe is used as heated pipe for various fins geometries. The rectangular fins have the same surface area of circular fins. The higher rate of fluid volume mixing (hot and cold) is presented within longitudinal fins more than the circular. The channelling effect is negligible at rectangular fins for equivalent surface area. Figure 20 shows the contour analysis (velocity and temperature) of mixed convection; longitudinal finned pipe is used as heated pipe of various  $R$ .

**Figure 18. Contour analysis of mixed convection of circular finned pipe of various  $R$ .**

The increase of  $R$  is shown to improve the hot fluid transports through the bulk fluid. The higher  $R$  provides the significant higher surface area with minimum channelling effect.

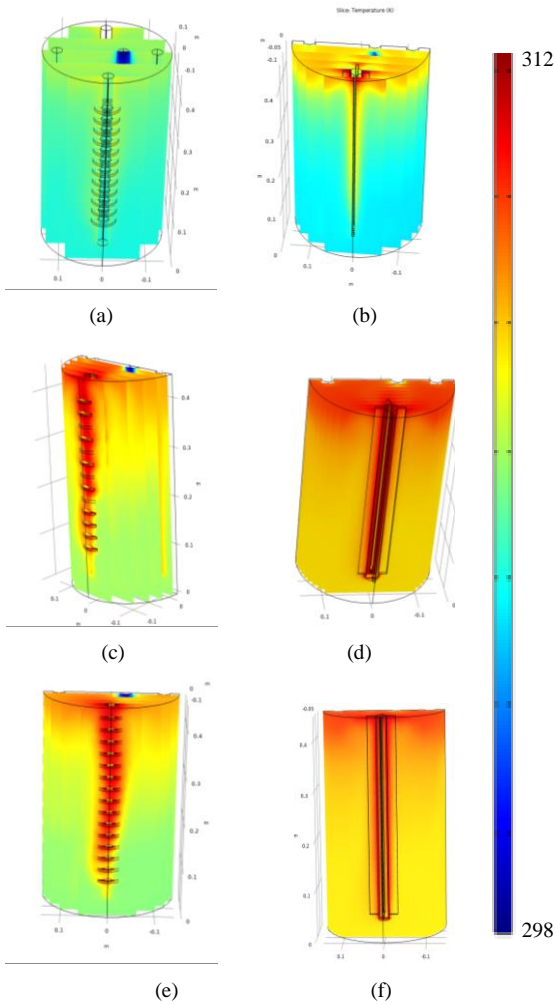
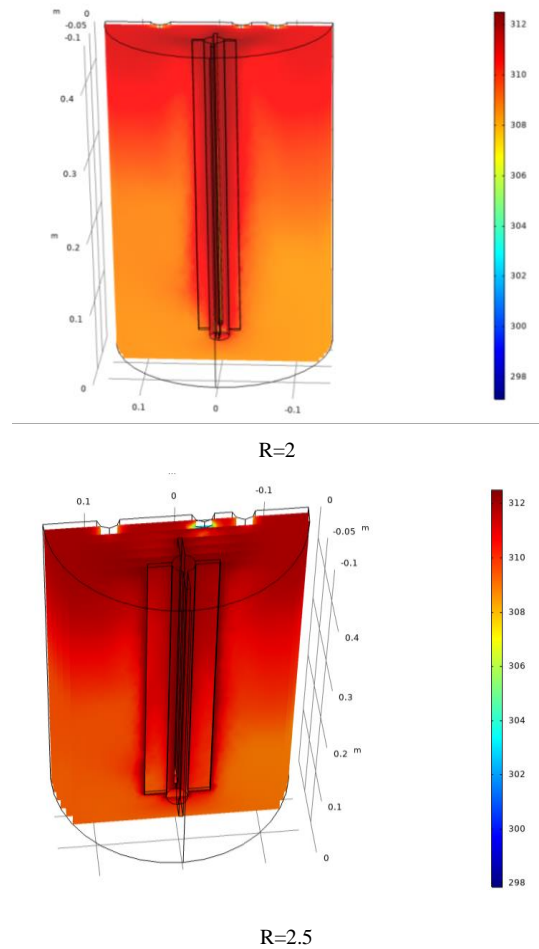

**Figure 19. Contour analysis of mixed convection of finned pipe of various fins geometries. a) Circular finned pipe of 12 fins, b) rectangular finned pipe of equivalent 12 fins, c) Circular finned pipe of 14 fins, d) rectangular finned pipe of equivalent 12 fins, e) Circular finned pipe of 16 fins, f) Rectangular finned pipe of equivalent 16 fins.**

Figure 21 shows the comparison between the present work and Bard, 1983 [19]. Mixed convection of two heaters where hot pipe was used and  $Ri=0.5$ . The results showed good agreement with previous work investigation with corresponding of 14 % as a maximum error.

**4. Conclusions**

The numerical investigation of mixed convection inside the cylindrical enclosure in presence and absence of fins has been investigated. The increase of  $Ri$  decreases the  $Nu$  significantly for both hot and cold regions. The high values of  $Ri$  promote the free convection mechanism while the lower  $Ri$  makes the heat transfer turns toward the forced convection. The  $Ri$  is considered the main criteria for heat transfer behaviours when the mixed convection is performed inside the enclosure. In the hot pipe region, the  $Nu$  values increased by increasing the  $As$  11.11 % heat transfer enhancement is observed at  $Ri=0.5$  and 20.8 % is observed at  $Ri=5.5$ .



**Figure 20. Contour analysis of mixed convection of rectangular finned pipe of various R.**

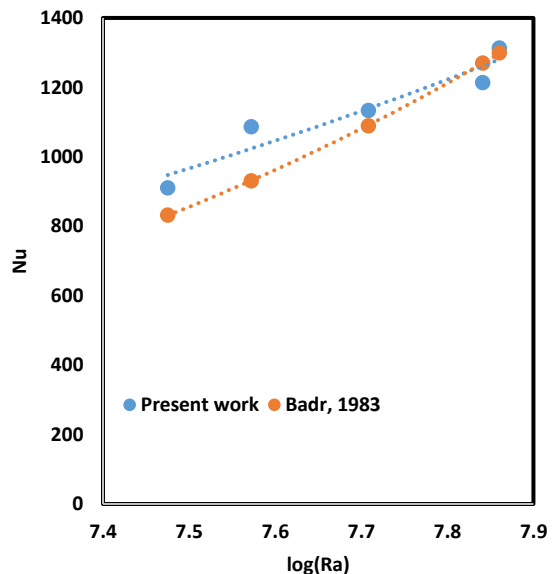

**Figure 21. The validation with previous work [19]**

In the cold pipe region, the opposite behaviour to the hot pipe region is obtained. The heat transfer performance is decreased when the aspect ratio increases. The heat transfer decreased by 12.22 % for  $Ri=0.5$  and 7.777 % for  $Ri=5.5$ . In high  $Ra$ , the  $Nu$  range values grow as the fins number increases, with no notable changes for the lower numbers (12 and 14). The effect of fins primarily serves as a measure of heat transfer surface area. When  $\log(Ra)=7.342$  and 16 fins are used, the maximum heat transfer improvement is 4.2 %. Throughout both hot and cold locations, the radius ratio has no influence on  $Nu$  for the whole  $Ri$  and  $Ra$ . For varied  $Ri$ , the turbulence sub-layer does not influence the free stream behaviour. For a single  $Ri$ , the whole plot in the cold zone has relatively close values. The  $Nu$  increases by increasing the  $As$  in the hot pipe region and decreases by increasing  $As$  in the cold pipe region. The heat transfer system needs the integration between the hot and cold regions heat transfer with the free stream to achieve thermal equilibrium. In other words, the amount of  $Nu$  number increases directly with  $As$  needs the reverse behaviour with  $As$  in cold region to achieve the thermal equilibrium.

The geometry has no significant effect on the  $Nu$  for high  $Ri$ . The dead zones are not presented in longitudinal fins, unlike the circular fins in which the channelling is formed due to geometrical configuration. For the cold region, the  $Nu$  decreases by 18 % in rectangular fins as compared with circular fins in low  $Ri$  number to achieve thermal equilibrium. The effect of channelling would be maximized by flow development. The maximum number of fins, the heat transfer enhancement decrease happens as shown in temperature and velocity profiles for various parameters.

#### Authors' contribution

All authors contributed equally to the preparation of this article.

#### Declaration of competing interest

The authors declare no conflicts of interest.

#### Funding source

This study didn't receive any specific funds.

#### References

- [1] Garbrecht O, Kabelac S, Kneer R. Large eddy simulation of three-dimensional mixed convection on a vertical plate. *Lehrstuhl für Wärme-und Stoffübertragung*; 2017.
- [2] Mansour NB, Ben-Cheikh N, Ben-Beya B, Lili T. Mixed Convection of Heat Transfer in a Square Lid-Driven Cavity. *International Letters of Chemistry, Physics and Astronomy*. 2015;55:181.
- [3] Khan M, Khan AA, Hasan MN, editors. Numerical study of mixed convection heat transfer from a rotating cylinder inside a trapezoidal enclosure. *AIP Conference Proceedings*; 2016: AIP Publishing LLC.
- [4] Garoosi F, Hoseininejad F. Numerical study of natural and mixed convection heat transfer between differentially heated cylinders in an adiabatic enclosure filled with nanofluid. *Journal of Molecular Liquids*. 2016;215:1-17.
- [5] Selimefendigil F, Ismael MA, Chamkha AJ. Mixed convection in superposed nanofluid and porous layers in square enclosure with inner rotating cylinder. *International Journal of Mechanical Sciences*. 2017;124:95-108.
- [6] Gangawane KM, Manikandan B. Mixed convection characteristics in lid-driven cavity containing heated triangular block. *Chinese Journal of Chemical Engineering*. 2017;25(10):1381-94.
- [7] Hussein AK. Entropy generation due to the transient mixed convection in a three-dimensional right-angle triangular cavity. *International Journal of Mechanical Sciences*. 2018;146:141-51.
- [8] Zhang W, Wei Y, Dou H-S, Zhu Z. Transient behaviors of mixed convection in a square enclosure with an inner impulsively rotating circular cylinder. *International Communications in Heat and Mass Transfer*. 2018;98:143-54.
- [9] Selimefendigil F, Öztöp HF. Mixed convection of nanofluids in a three dimensional cavity with two adiabatic inner rotating cylinders. *International Journal of Heat and Mass Transfer*. 2018;117:331-43.
- [10] Abdulsahib AD, Al-Farhany K. Experimental investigation of mixed convection on a rotating circular cylinder in a cavity filled with nanofluid and porous media. *Al-Qadisiyah Journal for Engineering Sciences*. 2020;13(2):99-108.
- [11] Hussein AK, Hamzah HK, Ali FH, Kolsi L. Mixed convection in a trapezoidal enclosure filled with two layers of nanofluid and porous media with a rotating circular cylinder and a sinusoidal bottom wall. *Journal of Thermal Analysis and Calorimetry*. 2020;141(5):2061-79.
- [12] El-Shorbagy M, Algehyne EA, Ibrahim M, Ali V, Kalbasi R. Effect of fin thickness on mixed convection of hybrid nanofluid exposed to magnetic field-Enhancement of heat sink efficiency. *Case Studies in Thermal Engineering*. 2021;26:101037.
- [13] Alshara AK, Abood FA, Shrama SM. An Experimental Investigation of Mixed Convection from a Finned Wall in an Inclined Rectangular Duct.
- [14] Rout SK, Mishra DP, Nath Thatoi D, Acharya AK. Numerical analysis of mixed convection through an internally finned tube. *Advances in Mechanical Engineering*. 2012;4:918342.
- [15] Kopeć P, Niezgodna-Żelasko B. Optimisation of the Geometric Parameters of Longitudinally Finned Air Cooler Tubes Operating in Mixed Convection Conditions. *Processes*. 2021;9(1):111.
- [16] Dogan M, Sivrioglu M. Experimental investigation of mixed convection heat transfer from longitudinal fins in a horizontal rectangular channel. *International Journal of Heat and Mass Transfer*. 2010;53(9-10):2149-58.
- [17] Mishra JKagaS. Computational Analysis of Mixed Convection of Internal Finned Tube. *International Journal of Engineering Research & Technology*. 2016;8.
- [18] Al-Taha WH, Osman HA, Majeed MH. Enhancement of Forced Convection Heat Transfer from Rectangular Fin with Different Forms of Perforation.
- [19] Bard, H. M., 1983, "A Theoretical Study of Laminar Mixed Convection From a Horizontal Cylinder in a Cross Stream," *International Journal of Heat and Mass Transfer*, Vol. 26, pp. 639-653.
- [20] Holman J. P., "Heat transfer", CRC Press, London , 2010.